

Glass bricks in ADU

The areas do not exceed 12 square feet each.

Glass blocks are permitted as a vertical wall opening under section 2110 of the IBC provided glass-block assemblies having a fire protection rating of not less than 3/4 hour shall be permitted as opening protectives in accordance with Section 715 in fire barriers and fire partitions that have a required fire-resistance rating of 1 hour or less and do not enclose exit stairways or exit passageways.

The bricks to be used are rated under ASTM E-119/NFPA 251/UL 263 as per the manufacturers framing (enclosed) that will include top, side and bottom 3/4" fire retardant gypsum sills and fire retardant sealant to edge of fire rated wall vertical wall with metal "L" channel as further protection.

TYPICAL SHELF ANGLE DETAILS – FOR VISTABRIK® PANELS

Continuous Panels ≤ 100 Sq. Ft. Each

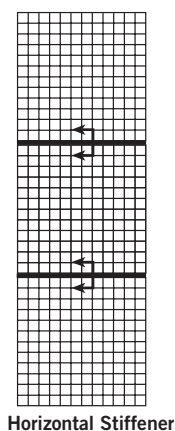

Horizontal Stiffener

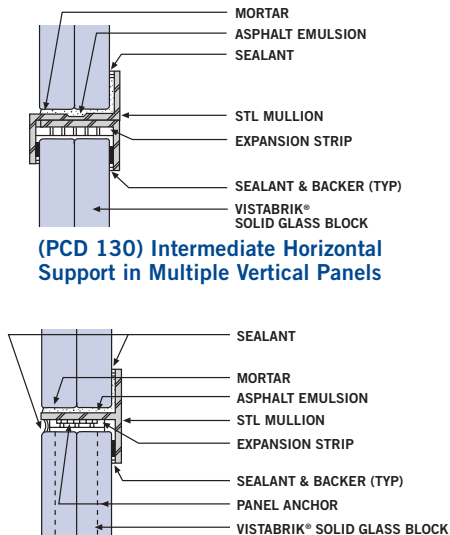

(PCD 130) Intermediate Horizontal Support in Multiple Vertical Panels

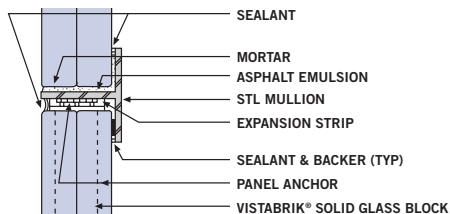

(PCD 131) Intermediate Horizontal Support in Multiple Vertical Panels

TYPICAL STIFFENER DETAILS – FOR VISTABRIK® PANELS

Continuous Panels ≤ 100 Sq. Ft. Each

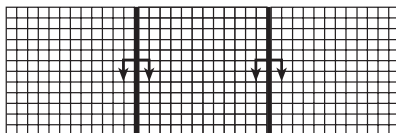

Vertical Stiffener

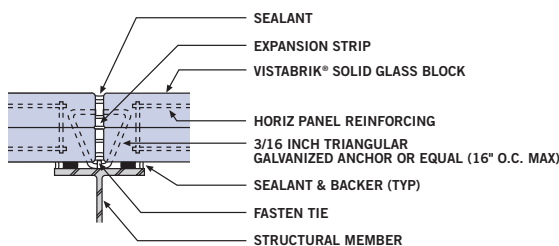

(PCD 133) Intermediate Vertical Support in Multiple Horizontal Panels

DETAILS FOR FIRE RATED CONSTRUCTION

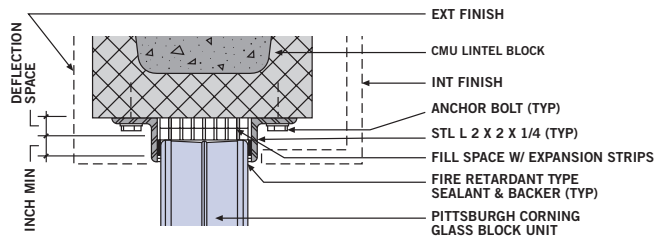

(PCD 004) Head – 90 Minute Fire Rated Glass Block in CMU Wall

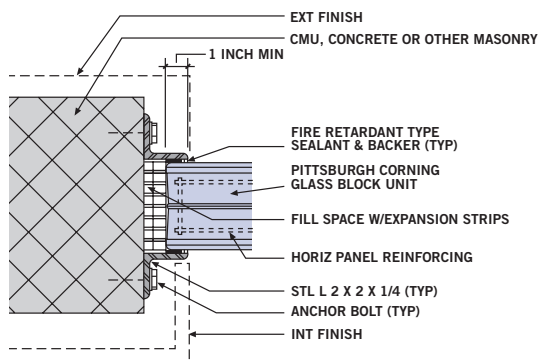

(PCD 005) Jamb – 90 Minute Fire Rated Glass Block in CMU Wall

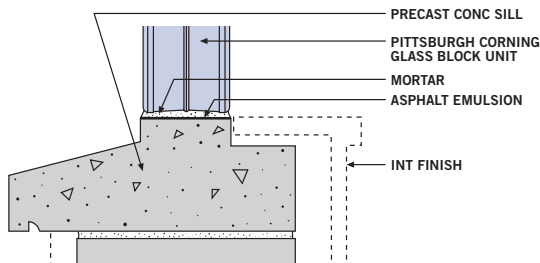

(PCD 006) Sill – 90 Minute Fire Rated Glass Block in CMU Wall

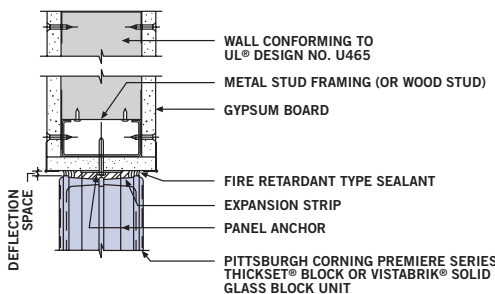

(PCD 159) Head – 45 & 60 Minute Fire Rated Glass Block Panel

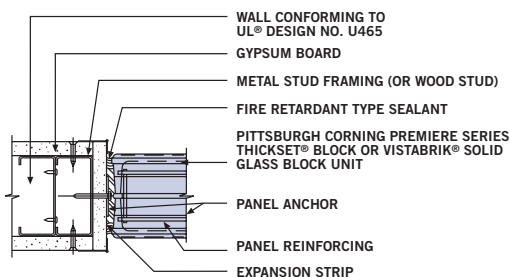

(PCD 160) Jamb – 45 & 60 Minute Fire Rated Glass Block Panel

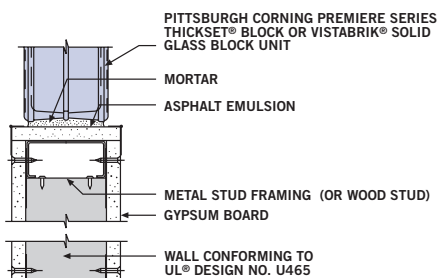

(PCD 161) Sill – 45 & 60 Minute Fire Rated Glass Block Panel

PITTSBURGH CORNING GLASS BLOCK PRODUCTS

HIGH PERFORMANCE LINE – Pittsburgh Corning’s High Performance Line of glass block products is comprised of products that offer the highest value, performance features and benefits related to improved safety, energy efficiency, aesthetics and decorative choices.



THICKSET® Block
Cutaways show the greater face thickness of the THICKSET® Series Block. THICKSET® 60 Block on left vs. the THICKSET® 90 Block on right.



THICKSET® 90 Block DECORA® Pattern
THICKSET® 90 block provides a 90-minute fire rating. The DECORA® pattern provides maximum light transmission with subtle visual distortion. The nondirectional faces make installation quick.

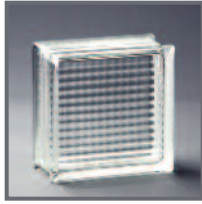

THICKSET® 90 Block ENDURA™ Pattern
THICKSET® 90 block provides a 90-minute fire rating. The ENDURA™ pattern’s narrow flutes provide moderate light transmission/maximum privacy.



THICKSET® 90 Block VUE® Pattern
THICKSET® 90 block provides a 90-minute fire rating. The VUE® pattern transmits maximum light and allows ultimate visibility.



THICKSET® 60 Block DECORA® Pattern
THICKSET® 60 block provides a 60-minute fire rating. The DECORA® pattern provides maximum light transmission with subtle visual distortion. The nondirectional faces make installation quick.



THICKSET® 60 Block VUE® Pattern
THICKSET® 60 block provides 60-minute fire rating. The VUE® pattern transmits maximum light and allows ultimate visibility.

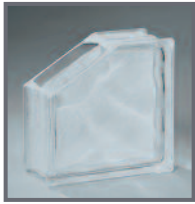

DECORA® LX Pattern
Fibrous glass insert adds moderate thermal and light characteristics. Maximum privacy. *Please note: The “LX” fibrous glass insert is available in other patterns and sizes by special order. Minimum order quantities apply.*

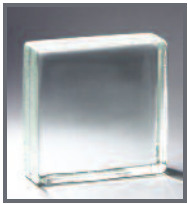

VISTABRIK® Solid Glass Block

3” solid glass block. Clear visibility, durable, impact, vandal and bullet resistant, low maintenance and aesthetically attractive. Excellent light transmission. Available in 8” x 8”, 6” x 8” and 4” x 8” sizes.



Glass Block Solar Wall Tubes

An easy way to let light into a structure that is built with multi-wythe walls. The Solar Wall Tubes replace standard masonry units and allow light transmission for LEED contribution. Improved thermal performance. Available in various sizes with choice of privacy levels.

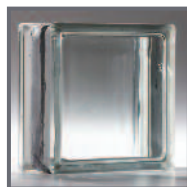
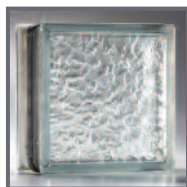
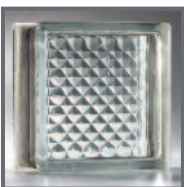

Energy Efficient Glass Block

Blocks out the sun’s heat and ultraviolet light – to help keep interiors cooler in the summer. In winter, improved insulating ability helps keep interiors warmer. The blocks are available in DECORA®, DELPHI®, IceScapes®, and VUE® patterns.

SIGNATURE LINE – Pittsburgh Corning’s Signature Line of glass block products is comprised of high quality Premiere Series products and the largest selection of patterns and shapes. This line has become the standard in the industry and provides the most design flexibility in the selection and use of glass block for walls, windows, partitions, and showers in residential and commercial applications.

Premiere Series Glass Block

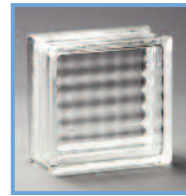

ARGUS® Pattern
Rounded perpendicular flutes diffuse light while allowing maximum light transmission and a medium degree of privacy.

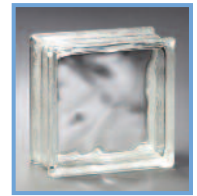

DECORA® Pattern
The trademark wavy undulations of this pattern provides maximum light transmission with subtle visual distortion. The nondirectional faces make installation quick.

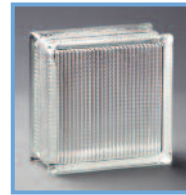

ESSEX® AA Pattern
The fine grid design of the closely spaced ridges in this pattern offers moderate light transmission and a maximum degree of privacy.

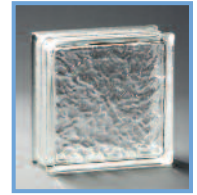

IceScapes® Pattern
Non-directional pattern lets light in without sacrificing privacy. Maximum light transmission/medium to maximum privacy.

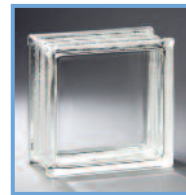

VUE® Pattern
Faces are smooth and undistorted to transmit the most light and allow ultimate visibility. This is your best choice for passive solar collection and visual clarity.

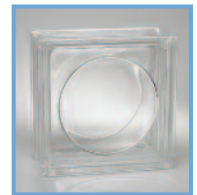

FOCUS™ Pattern
This new circular pattern gives an exciting new way to bring more light and drama to any project.

SIGNATURE LINE – (continued)

Premiere Series Glass Block (continued)

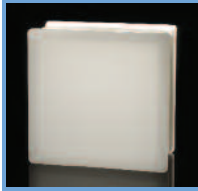

Opal Plain
With a smooth finish both inside and out, this style emits a softly diffused light over an entire area.

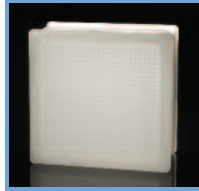

Opal Silk
This fine grid pattern on the inner surface provides an elegant setting as it gently spreads light.

Shapes and Finishing Units



**ARQUE® Block
DECORA® and IceScapes® Patterns**
ARQUE® Block is a brilliant way to create smooth, graceful curves and columns. ARQUE® Block forms a consistent, tight curve ideally suited for columns.

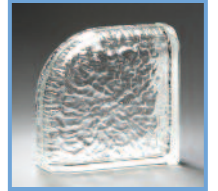

**ENCURVE® Block,
DECORA® and IceScapes® Patterns**
Arched, soft edges to round out your design options or finish panels. Use with 8" x 8" EndBlock™ Finishing Units for a stepped panel.



EndBlock™ Finishing Unit DECORA® and IceScapes® Patterns 6" x 8" and 8" x 8"
The rounded, finished surface on one edge of these blocks makes them virtually disappear when used vertically or horizontally on the edges of panels, walls or dividers.

possibilitiesbegin.com

Visit our new website which was designed specifically to help you to imagine the possibilities.



**HEDRON® Corner Block
DECORA® and IceScapes® Patterns**
Hexagonal corner unit allows you to form 90-degree corners resulting in a gently rounded continuous glass face.



**TRIDRON 45° Block®
DECORA® and IceScapes® Patterns**
The unique shape of this block lets you create everything from 45-degree angles to full circles.

MADE TO ORDER PRODUCTS – Items listed below are subject to minimum order quantities and lead times.

Premiere Series Glass Block

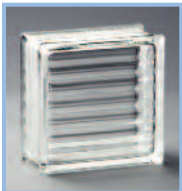

ARGUS® Parallel Fluted Pattern
Rounded parallel flutes on each face diffuse light while allowing maximum light transmission and a medium degree of privacy. Compliments the SPYRA® pattern.



SeaScapes™ Pattern
The three dimensional circles appear to float within the glass block. The pattern lets in light and also provides a degree of privacy.

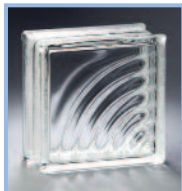

SPYRA® Pattern
SPYRA® Pattern gives you many options for decorative patterns, such as bold circles, rounded corners and the illusions of waves. Maximum light transmission and minimal privacy.

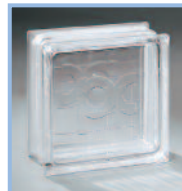

PC® Custom Signature Block
Custom manufactured with your corporate logo or other design pressed into one or both inside surfaces of an eight inch square, standard unit.

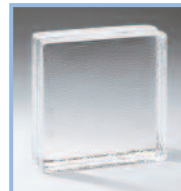

VISTABRIK® Stippled Glass Block
Solid 3" thickness of glass with a stippled finish to add privacy. Durable, impact, vandal and bullet resistant, low maintenance and aesthetically attractive. Good light transition/medium privacy.



**HEDRON® LX Corner Block,
DECORA® Pattern**
Hexagonal corner unit allows you to form 90-degree corners resulting in a gently rounded continuous glass face.

PHYSICAL & DESIGN DATA

PITTSBURGH CORNING GLASS BLOCK PRODUCTS

Pattern	Nominal Size ¹ (Actual size is 1/4" less than nominal; mm shown is actual)	Weight (lb/ft ²) installed with mortar	Heat Transmission ² U Value (Btu/hr ft ² °F)	Thermal Resistance ² R Value (hr ft ² °F/Btu)	Visible Light Transmission ³ (%)	Shading Coef. ⁴	Sound Transmission S.T.C.	Solar Heat Gain Coefficient ⁵	
THICKSET® Block — Nominal Thickness = 4"; Actual Thickness = 3 7/8" (98mm)									
THICKSET® 60 Block— DECORA® & VUE®	8" x 8" (197mm)	25	0.51	1.96	VUE®=75 DECORA®=49	0.65	48	.66-.68 ⁵	
THICKSET® 90 Block— DECORA® & VUE®	8" x 8" (197mm)	30	0.51	1.96	VUE®=70 DECORA®=38	0.65	50	.66-.68 ⁵	
THICKSET® 90 Block— ENDURA™	8" x 8" (197mm)	30	0.51	1.96	38	0.65	50	.66-.68 ⁵	
Glass Block with "LX" Fibrous Glass Inserts — Nominal Thickness = 4"; Actual Thickness = 3 7/8" (98mm)									
DECORA®	6" x 6" (146mm) †	20	0.48	2.06	44	0.45 ⁴		.56	
"LX" Filter	8" x 8" (197mm)	20	0.48	2.06	44	0.45 ⁴	40	.56	
	12" x 12" (299mm) †	20	0.48	2.06	44	0.45 ⁴		.56	
VISTABRIK® Solid Glass Block — See Nominal/Actual Sizes Listed									
VISTABRIK® Solid Glass Block	8" x 8" x 3" Nominal 7 7/8" x 7 7/8" x 3" Actual (194mm x 194mm x 76mm)	40	0.87	1.15	90		53 (NRC=0.05)	.75-.78 ⁵	
	6" x 8" x 3" Nominal 5 5/8" x 7 7/8" x 3" Actual (143mm x 194mm x 76mm)	40	0.87	1.15	90			.75-.78 ⁵	
	4" x 8" x 3" Nominal 3 5/8" x 7 7/8" x 3" Actual (92mm x 194mm x 76mm)	40	0.87	1.15	90			.75-.78 ⁵	
STIPPLE Finish	8" x 8" x 3" Nominal 7 7/8" x 7 7/8" x 3" Actual (194mm x 194mm x 76mm) †	40	0.87	1.15	83		53 (NRC=0.05)	.75-.78 ⁵	
Energy Efficient Glass Block — See Nominal/Actual Sizes Listed									
DECORA®, DELPHI®, Ice Scapes®, and VUE®	8" x 8" x 3 1/2" Nominal 7 3/4" x 7 3/4" x 3 1/2" Actual (197mm x 197mm x 89mm)	40	.45	2.22	63 33 50 76			.32	
Standard Premiere Series Block — Nominal Thickness = 4"; Actual Thickness = 3 7/8" (98mm)									
SIGNATURE LINE	ARGUS®	6" x 6" (146mm)	20	0.51	1.96	55	0.65	37	.66-.68 ⁵
		8" x 8" (197mm)	20	0.51	1.96	55	0.65	39	.66-.68 ⁵
		12" x 12" (299mm)	20	0.51	1.96	55	0.65	35	.66-.68 ⁵
	DECORA®	6" x 6" (146mm)	20	0.51	1.96	75	0.65	37	.66-.68 ⁵
		8" x 8" (197mm)	20	0.51	1.96	75	0.65	39	.66-.68 ⁵
		12" x 12" (299mm)	20	0.51	1.96	75	0.65	35	.66-.68 ⁵
		4" x 8" (95 x 197mm)	20	0.51	1.96	75	0.65		.66-.68 ⁵
		6" x 8" (146 x 197mm)	20	0.51	1.96	75	0.65		.66-.68 ⁵
	ESSEX® AA	8" x 8" (197mm)	20	0.51	1.96	45	0.45	39	.66-.68 ⁵
	FOCUS™	8" x 8" (197mm)	20	0.51	1.96	92	0.65	39	.66-.68 ⁵
	IceScapes®	8" x 8" (197mm)	20	0.51	1.96	67	0.65	39	.66-.68 ⁵
		12" x 12" (299mm)	20	0.51	1.96	67	0.65	35	.66-.68 ⁵
		4" x 8" (95 x 197mm)	20	0.51	1.96	67	0.65		.66-.68 ⁵
		6" x 8" (146 x 197mm)	20	0.51	1.96	67	0.65		.66-.68 ⁵
	Opal Plain	8" x 8" (197mm)	20			19			
	Opal Silk	8" x 8" (197mm)	20			17			
	SeaScapes™	8" x 8" (197mm) †	20	0.51	1.96	64	0.65	39	.66-.68 ⁵
	VUE®	6" x 6" (146mm)	20	0.51	1.96	91	0.65	37	.66-.68 ⁵
		8" x 8" (197mm)	20	0.51	1.96	91	0.65	39	.66-.68 ⁵
		12" x 12" (299mm)	20	0.51	1.96	91	0.65	35	.66-.68 ⁵
	4" x 8" (95 x 197mm)	20	0.51	1.96	91	0.65		.66-.68 ⁵	
	6" x 8" (146 x 197mm)	20	0.51	1.96	91	0.65		.66-.68 ⁵	
1/8" FLAT SHEET GLASS COMPARISON (3mm)				1.04	0.96	90	1.00	28	

1 Size: Block are manufactured to a ± 1/16" (2mm) tolerance.

2 Heat Transmission/Thermal Transmission: Winter night values. To calculate instantaneous

heat gain through glass panels, see ASHRAE HANDBOOK OF FUNDAMENTALS, 2005, Section 31.3.

3 Light Transmission: Based on test results.

4 Shading Coefficient: Estimated figures based on accumulated data.

5 SHGC: Default values as interpreted from International Energy Conservation Code.

† MTO – Made to Order items subject to minimum order quantities and lead times.

Installed Panel Weight

Refer to Table on page 8 for weight of panels installed with mortar. Glass block panels installed with the ProVantage® Glass Block Installation System are up to 25% lighter per square foot than panels installed with mortar. Local building codes should be consulted for any limits on panel sizes or installation details.

Non-load Bearing

Glass block panels are non-load bearing; adequate provisions must be made for support of construction above these

panels. Panels are mortared at the sill, with jamb and head details designed to accommodate for building movement and lintel deflection. The compressive strength (for information purposes only) of all hollow glass block is 400 to 600 psi.; THICKSET® Series Glass Block is 2500 psi.; and VISTABRIK® Series is 80,000 psi.

Thermal Expansion Coefficient

The thermal expansion coefficient of glass block is $47 \times 10^{-7} / (^\circ\text{F})$.

Detailed Drawings

Structural members illustrated on page 14 and other "detail" pages indicate general principles of construction. Member sizes should be determined by structural analysis to avoid excessive deflections. Maximum deflection for supports shall not exceed $L/600$.

FINISHING UNITS

PREMIERE SERIES

EndBlock™ Finishing Units		HEDRON® Corner Unit	TRIDRON 45° Block® Unit	ENCURVE® Finishing Unit	ARQUE® Block Unit
DECORA® & IceScapes® Patterns 8" High Premiere Series	DECORA® & IceScapes® Patterns 8" High Premiere Series	DECORA® & IceScapes® Patterns 8" High Premiere Series	DECORA® & IceScapes® Patterns 8" High Premiere Series	DECORA® & IceScapes® Patterns 8" Square Premiere Series	DECORA® & IceScapes® Patterns 8" High Premiere Series

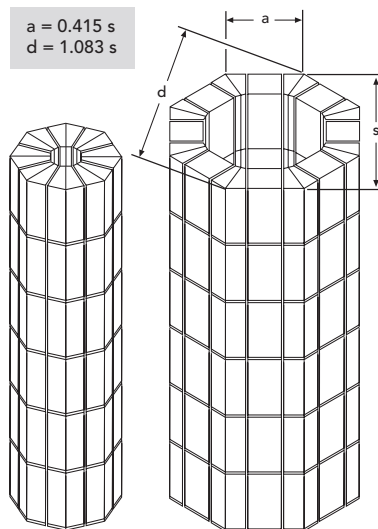

Columns can be All-TRIDRON 45° Block® (left) or interspersed with 4" x 8" or 8" x 8" glass block.

NOTE: All mortar joints are 1/4".

Glass Block between TRIDRON 45° Block®

	a (in.)	s (in.)	d (in.)
None	4.75	11.45	12.40
1-4" x 8" x 4"	8.75	21.08	22.83
1-6" x 8" x 4"	10.75	25.90	28.05
1-8" x 8" x 4"	12.75	30.72	33.27
1-4" x 8" x 4" + 1-8" x 8" x 4"	16.75	40.36	43.71
2-8" x 8" x 4"	20.75	50.00	54.15
1-4" x 8" x 4" + 2-8" x 8" x 4"	24.75	59.64	64.59
3-8" x 8" x 4"	28.75	69.28	75.03

Maximum Panel Dimensions

	Premiere Series			Thinline® Series			VISTABRIK®		
	A (Sq.Ft.)	H (Ft.)	W (Ft.)	A (Sq.Ft.)	H (Ft.)	W (Ft.)	A (Sq.Ft.)	H (Ft.)	W (Ft.)
EXTERIOR*	144	20	25	100	10	15	100	10	10
INTERIOR	250	20	25	150	10	15	150	10	15

A = Area H = Height W = Width

* All exterior areas and dimensions are based on 20 psf design windload with 2.7 safety factor.

Mortar Mix and Estimating Tables

An optimum mortar mix for installing Pittsburgh Corning Glass Block is:

Portland Cement	Lime	Sand
1 Part	1/2 Part	3.4 Parts
1.0 cubic foot	0.5 cubic foot	3.4 cubic feet

Number of Block for 100 Sq. Ft. Panel

Block Sizes (Nominal)	6"	8"	12"	4" x 8"	6" x 8"
Number of Block	400	225	100	450	300

PHYSICAL & DESIGN DATA

INSIDE RADIUS MINIMUMS FOR CURVED PANEL CONSTRUCTION

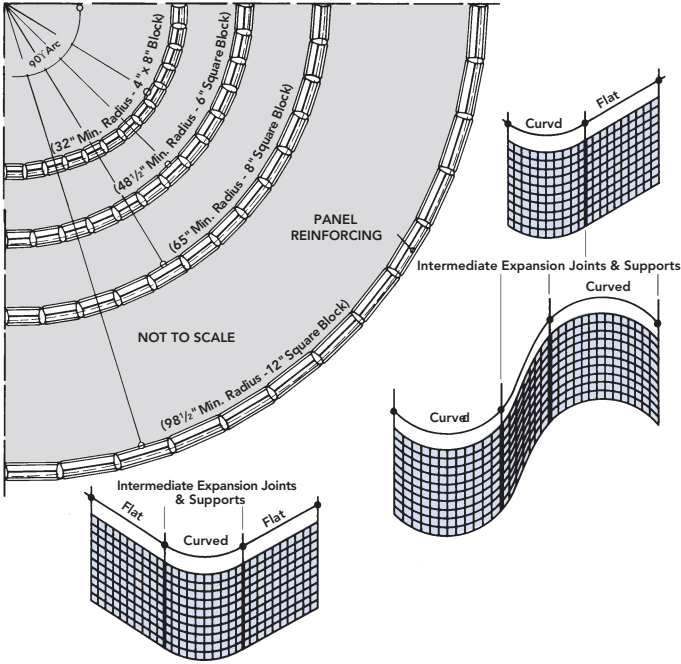

Block Size	Inside Radius Inches	Number of Blocks in 90° Arc	Vertical Joint Thickness In Inches	
			Inside	Outside
4" x 8"	32	13	1/8	5/8
6" x 6"	48 1/2	13	1/8	5/8
8" x 8"	65	13	1/8	5/8
12" x 12"	98 1/2	13	1/8	5/8

- NOTES:**
1. It is suggested that curved areas be separated from flat areas by intermediate expansion joints and supports, as indicated in these drawings.
 2. When straight, ladder-type reinforcing is used on curved walls, the innermost parallel wire may be cut periodically and/or bent to accommodate the curvature of the wall.

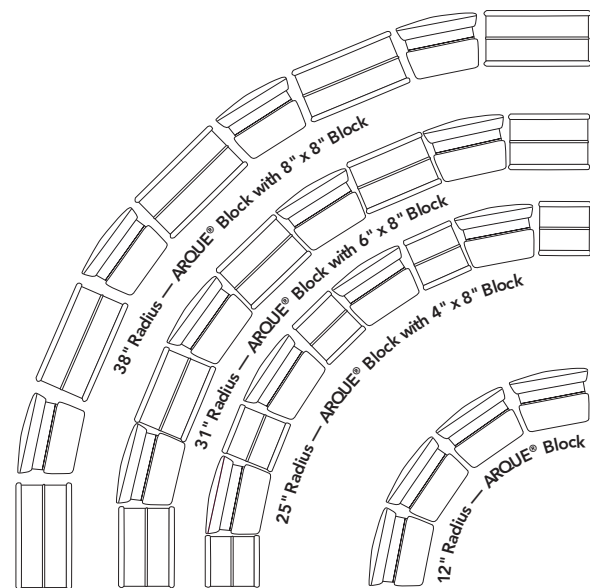

ARQUE® Block used along with other Pittsburgh Corning Block sizes, allows you to form consistent curves of various radii. Radii shown are to inside face of curve.

WIND LOAD RESISTANCE – MORTAR SYSTEM

(Based on Standard Nominal 4" Thick Premiere Series Glass Block Installed with mortar. Based on 2.7 Safety Factor)

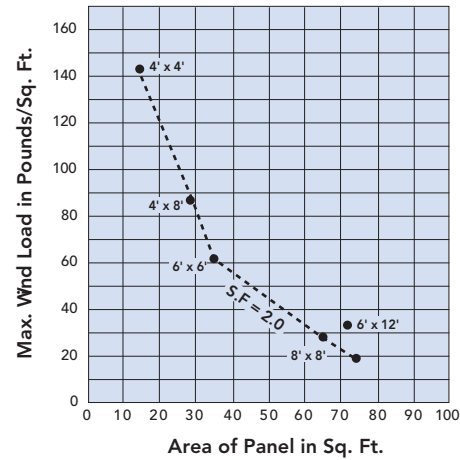
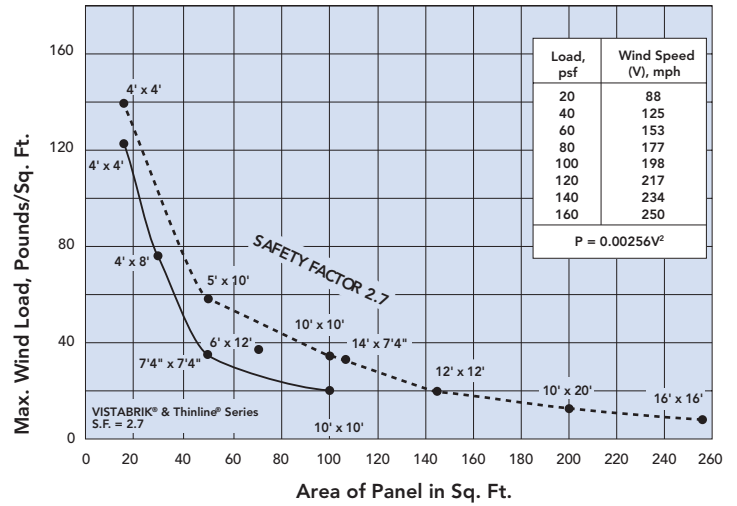

WIND LOAD RESISTANCE – PROVANTAGE® SYSTEM

(Based on Standard Nominal 4" Thick Premiere Series Glass Block Installed with ProVantage® Silicone System). Based on 2.0 Safety Factor.

RESISTANCE TO SURFACE CONDENSATION

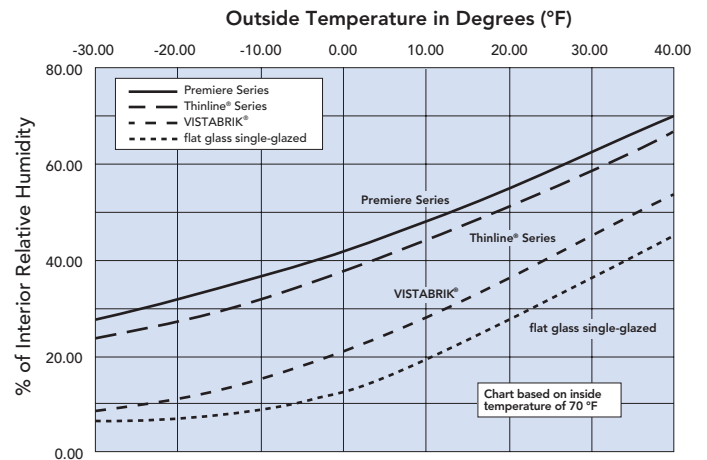

Example: At a relative humidity of 40%, an outside temperature of approximately -3 °F will cause condensation on Premiere Series Glass Block or approximately 3 °F above zero on Thinline® Series block. Under the same conditions, condensation will form on a single-glazed flat glass window at 34 °F above zero.

FIRE RATINGS & CODE INFORMATION

All sizes (exceptions listed below) of Premiere Series and Thinline® Series glass blocks have at least a 45 minute fire rating when used as a window assembly within a one hour fire-rated wall assembly. All THICKSET® 90 (thick-faced) and solid glass blocks have fire ratings of up to 90 minutes, and the THICKSET® 60 and ESSEX® AA Pattern glass blocks have fire ratings of up to 60 minutes, when used as window assemblies and where permitted by code.

Pittsburgh Corning Glass Block units that are not fire-rated:

- All 12" x 12" sizes
- All DELPHI®, pattern block
- All HEDRON® Corner block, TRIDRON 45° Block® units, EndBlock®, ENCURVE® and ARQUE® finishing units
- All paver units
- VISTABRIK® Corner Block

PANEL SIZES AND DIMENSION LIMITATIONS

Pittsburgh Corning Glass Block listed above have been tested and classified by Underwriters Laboratories® (UL®) for use as fire-rated window assemblies to panel sizes and dimension limitations listed below:

- With the exception of all 12" x 12" sizes, finishing blocks, corner blocks and the DELPHI® pattern block, all Premiere Series and Thinline® Series glass blocks in panels up to 120 square feet in masonry walls or 94 square feet in non-masonry walls are classified by Underwriters Laboratories, for use as 45-minute rated window assemblies.
- These panels are usually acceptable as window assemblies for use in fire separation walls that are rated one hour or less.
- THICKSET® 60 Block are listed for use as 45- or 60-minute fire rated window assemblies in panels up to 100 square feet.

- THICKSET® 90 Block and VISTABRIK® Solid Glass Block are all listed for use as 45-, 60- or 90-minute fire rated window assemblies in panels up to 100 square feet.
- Where permitted by building codes, glass block fire-rated window assemblies having a fire resistance rating of not less than 45 minutes may be used as "opening protectives". These assemblies shall not exceed 25% of the wall areas separating a tenancy from a corridor or a corridor from an enclosed vertical opening or one fire-rated area from another fire-rated area.
- **Exception:** Although glass block masonry systems have been tested as window assemblies (not wall assemblies), they may be used as one hour fire partitions as required for corridors in the enclosure of atriums only when sprinkler protection is provided on occupied sides.

45- AND 60-MINUTE RATED CONSTRUCTION

- All 45- and 60-minute rated Pittsburgh Corning Glass Block may be used in both masonry and non-masonry (steel or wood stud framing with gypsum board) walls.
- These rated glass block windows may be framed and anchored with either PC® Panel Anchor construction or channel-type restraints.
- The use of a fire retardant type sealant for head and jamb locations is required.
- Specifications and construction details for such panels are as per Pittsburgh Corning Corporation recommendations.
- Non-masonry, fire-rated steel stud with gypsum board wall assemblies must conform to UL® listed wall assembly #U465.

- Framing and support of the rated glass block window assembly shall be provided with double-studding at the jamb locations with height of supporting wall limited to no more than 3 feet.

90-MINUTE RATED CONSTRUCTION

- Where permitted by building codes, all 90-minute rated Pittsburgh Corning Glass Block may be used in masonry walls only.
- 90-minute rated glass block window assemblies must be framed and anchored with 1/4" thick steel (not aluminum) channel-type restraints or masonry chases. The use of panel anchor construction is not permitted.
- The use of a fire retardant type sealant for head and jamb locations is required.
- Specifications and construction details of such panels are as per Pittsburgh Corning Corporation recommendations.
- Twice the typical thickness (3/4" total) of expansion material is required at head and jamb locations.

45-MINUTE RATED CURVED CONSTRUCTION

- The glass blocks noted under 90-minute rating and those 8" x 8" x 4" sized glass block noted under 45-minute rating are classified for use in masonry walls as curved window assemblies, provided that the radius of the assembly is at least twice the opening width (i.e. chord length).

CODE COMPLIANCE

All of our fire-rated glass block products are listed in the Underwriters Laboratories current issue of the Fire Resistance Directory – Volume 3. A listing of our products can also be viewed on the Underwriters Laboratories Website at www.ul.com.

- U.L. Classification: R2556 (For Glass Block)
- U.L. Classification: R18572 (For Plastic Spacers)
- In accordance with NFPA 80, Chapter 14

CITY CODE APPROVALS

- New York City Materials and Equipment Acceptance MEA 406- 90-M. Vol.IV
- Los Angeles Research Report RR-24486
- Dade County Acceptance 07-0626.10
04-0301.01
04-0824.01
05-1107.02
08-0731.08
- State of Florida Approvals
FL 1363
FL 1366
FL 5357
FL 8039
FL 11669
- Texas Department of Insurance WIN #s 62, 63, 64, and 540

BUILDING CODE AND NATIONAL STANDARDS REFERENCES:

- International Building Code (IBC)
- International Residential Code (IRC)
- Canadian Standards Association (CSA) A371-94 "Masonry Construction for Buildings"
- Canadian Standards Association (CSA) S304.1-94 "Masonry Design for Buildings"
- TMS 402/ACI 530/ASCE 5 "Building Code Requirements and Specification for Masonry Structures"

Fire Ratings — Glass Block Assemblies

Premiere Series Glass Blocks, THICKSET® 60 Blocks, THICKSET® 90 Blocks and 3" thick VISTABRIK® Solid Glass Block units have been tested and classified by Underwriters Laboratories (UL®) for use in fire-rated window assemblies to panel sizes and dimension limitations as listed.

Product	Masonry Wall Construction					Non-Masonry Wall Construction			
	Panel Limitations		Fire Rating			Panel Limitations		Fire Rating	
	Max. Area/Panel	Max Ht. or Width	45 Min.	60 Min.	90 Min.	Max. Area/Panel	Max Ht. or Width	45 Min.	60 Min.
Thinline® Series**	120	12	X			94	10.75	X	
Premiere Series**	120	12	X			94	10.75	X	
THICKSET® 60 and ESSEX® AA Pattern**	100	10	X	X		94	10.75	X	X
THICKSET® 90	100	10	X	X	X*	94	10.75	X	X
VISTABRIK®	100	10	X	X	X*	94	10.75	X	X

* 1/4" steel channel. 3/4" thick expansion material at head and jambs, and fire retardant sealant are required.

** Includes "LX" option.

NOTICE OF PRODUCT CERTIFICATION



CERTIFICATION NO: NI013737
DATE: 06/01/2017
CERTIFICATION PROGRAM: Structural
COMPANY: Seves Glass
CODE: 2322-1
EXPIRATION DATE: 06/30/2021

To verify that the "Notice of Product Certification" is valid, please visit www.NAMICertification.com to assure that the product is active and currently listed. This certification represents product conformity to the applicable specification and that certification criteria has been satisfied. A NAMI approved certification label must be applied to the product to claim certification status. Please review and advise NAMI if any corrections are required to this document

COMPANY NAME AND ADDRESS	PRODUCT DESCRIPTION
Seves Glass Block, Inc. 10576 Broadview Road Broadview Heights, OH 44147	Series "Nubio Thickset 60" Fire-Rated Glass Block Manufacturer Specific Glass Blocks for Installation in 60 Minute Locations Max Opening: 94ft ² or W-128.5" or H-104.5" Glass Block Weight: 6.8 lb Glass Block Size: 8" x 8" Minimum Thickness: 4" Minimum Face Thickness: 7/16"

SPECIFICATION	PRODUCT RATING
ANSI/UL 9	60 Minutes With Hose Stream

TEST REPORT
Underwriters Laboratory Test Report No: R2556 02NK10299, R2556 79NK1, R2556 91NK10106, R2556 95NK20176

A handwritten signature in black ink, appearing to be "S. D.", written over a horizontal line.

Administrator's Signature: _____

**NATIONAL ACCREDITATION AND
MANAGEMENT INSTITUTE, INC.**

4794 George Washington Memorial Highway
Hayes, VA 23072

Tel: (804) 684-5124

Fax: (804) 684-5122