



City of Portland  
**Bureau of Development Services**  
Land Use Services Division

1900 SW Fourth Ave. Suite 5000  
Portland, Oregon 97201  
Telephone: 503-823-7300  
TDD: 503-823-6868  
FAX: 503-823-5630  
[www.portlandonline.com/bds](http://www.portlandonline.com/bds)

**Date:** June 13, 2008  
**To:** Interested Person  
**From:** Chris Caruso, Land Use Services  
503-823-5747 / [Christine.Caruso@ci.portland.or.us](mailto:Christine.Caruso@ci.portland.or.us)

**NOTICE OF A TYPE II DECISION ON A PROPOSAL IN YOUR NEIGHBORHOOD**

The Bureau of Development Services has approved a proposal in your neighborhood. The reasons for the decision are included in this notice. If you disagree with the decision, you can appeal it and request a public hearing. Information on how to appeal this decision is listed at the end of this notice.

**CASE FILE NUMBER: LU 08-103034 DZ - 10115 SE STARK STREET**

**GENERAL INFORMATION**

**Applicant:** Chris Harris [developer]  
Mcintyre Construction Inc.  
1500 Westec Drive  
Eugene, OR 97402  
(541) 687-2841

**Representative:** Susan Sandelman [owner]  
185 NW Spanish River Blvd  
PO Box 500  
Boca Raton, Fl 33431-4230

**Site Address:** 10115 SE STARK ST

**Legal Description:** TL 5400 1.85 ACRES, SECTION 33 1 N 2 E  
**Tax Account No.:** R942335100  
**State ID No.:** 1N2E33DD 05400  
**Quarter Section:** 3040

**Neighborhood:** Hazelwood, contact Arlene Kimura at 503-252-9429.  
**Business District:** Gateway Area Business Association, contact Fred Sanchez at 503-256-3910.  
**District Coalition:** East Portland Neighborhood Office, contact Richard Bixby at 503-823-4550.

**Plan District:** Gateway  
**Zoning:** CXd – Central Commercial with design overlay  
**Case Type:** DZ – Design Review  
**Procedure:** Type II, an administrative decision with appeal to the Design Commission.

**Proposal:**

Exterior alterations to an existing concrete block and storefront glazed building at the NW corner of SE 102<sup>nd</sup> Avenue and SE Stark Street. This includes installing a new glazed entry door in the south façade; adhering reflective film to the upper level of storefront glazing on the south façade; filling in two garage doors and one man door with concrete block, installing two new man doors and replacing the existing ramp and handrail with a concrete stair and metal handrail on the east elevation; installing a new illuminated sign across the front canopy sign band; new canopy downlights and rear door security lights; new rooftop mechanical unit; renovating the parking lot and parking lot landscaping; removing the existing freestanding sign posts and cabinet.

The site has a design overlay and must go through design review.

**Relevant Approval Criteria:**

In order to be approved, this proposal must comply with the approval criteria of Title 33, Portland Zoning Code. The relevant approval criteria are:

- 33.825 Design Review
- Gateway Regional Center Design Guidelines

**ANALYSIS**

**Site and Vicinity:** The 88,467 SF site is located on the northwest corner of SE Stark Street and SE 102<sup>nd</sup> Avenue and is within the Gateway Plan District and the Gateway Pedestrian District. The Russellville residential complex is directly to the northeast of the site and Mall 205 is directly to the southeast at SE Washington and SE 103<sup>rd</sup> Avenue. The area has a number of older auto-oriented developments with large surface parking lots butting up against the sidewalks, wide curb cuts, very little landscaping and numerous freestanding pole signs. SE Stark and SE Washington Streets form a couplet through this area and serve as the major vehicle transportation routes to and from I-205 to the west. Bus transit is available on SE 102<sup>nd</sup> Avenue.

SE 102<sup>nd</sup> is highlighted in the Gateway Regional Center Design Guidelines Urban Design Concept as a future tree-lined boulevard with street-level pedestrian amenities while the intersection of SE 102<sup>nd</sup> Avenue, SE Stark Street, SE 103<sup>rd</sup> Avenue and SE Washington Street is designated as a Gateway Location. Both SE 102<sup>nd</sup> Avenue and SE Stark are designated Major Transit Priority streets.

**Zoning:** The CX zone is intended to provide for commercial development within Portland's most urban and intense areas. A broad range of uses is allowed to reflect Portland's role as a commercial, cultural and governmental center. Development is intended to be very intense with high building coverage, large buildings, and buildings placed close together.

The “d” overlay promotes the conservation and enhancement of areas of the City with special historic, architectural or cultural value. New development and exterior modifications to existing development in the Gateway Plan District are subject to design review.

**Land Use History:** City records indicate that prior land use reviews include the following:  
LU 06-112593 DZ: Approval for Kia sign

**Summary of Applicant's Statement:** use at your discretion to further explain proposal and/or how they propose to mitigate for impacts or meet approval criteria.

**Agency Review:** A “Notice of Proposal in Your Neighborhood” was mailed **May 20, 2008**. The following Bureaus have responded with no issues or concerns:

- Water Bureau
- Fire Bureau
- Bureau of Parks-Urban Forestry Division
- Bureau of Transportation Engineering

The Site Development Section of BDS responded with the following comment: Please see Exhibit E-1 for additional details.

Site Development has reviewed the modified parking lot drainage plan in response to the need to comply with the BES SWMM for nonconforming landscape upgrades and finds it acceptable. The applicant has shown infiltration planters to the extent where practicable and since overall impervious area is not increasing, the planters may overflow into the existing on site drainage system, which has no known problems with capacity at this time. The plumbing connections and/or drywell locations may need to be modified at the time of construction as exact location becomes known, but these will all be underground and should have no impact on this land use decision.

The Life Safety Section of BDS responded with the following comment: Please see Exhibit E-2 for additional details.

The following comments are intended to provide the applicant with preliminary Building Codes information that could affect the Land Use Review and/or future Building Permit reviews. The comments may not identify all conflicts between the Land Use proposal and the Building Codes. A complete Life Safety plan review will be provided at the time of Building Permit submittal. The comments are based on The Oregon Structural Specialty Code, The Oregon Mechanical Specialty Code, or The Oregon Residential Specialty Code.

1. A separate Building Permit is required for the work proposed and the proposal must be designed to meet all applicable building codes and ordinances. More information regarding building code requirements can be obtained by visiting the Bureau of Development Services Development Services Center -1900 SW 4<sup>th</sup> Ave, 1<sup>st</sup> floor, between the hours of 7:30 AM and 3:00 PM Monday through Friday and also 5:00 PM to 7:30 PM Thursday evening (no appointment necessary.) Building Code information is also available online at: <http://www.portlandonline.com/bds/>, or by calling (503) 823-1456.

The Bureau of Environmental Services responded with the following comment: Please see Exhibit E-3 for additional details.

BES has no objections to the proposed exterior alterations. Further development of the property would be subject to the Bureau of Environmental Services' standards and requirements during the building plan review process. The following comments have been provided for informational purposes and mainly relate to the building permit review process:

#### Sanitary Services

1. There are City-owned sanitary-only sewers located in SE Pine Street, SE 102<sup>nd</sup> Avenue and SE Stark Street.

#### Stormwater Management & Water Resources

Stormwater runoff generated from proposed development must meet the requirements of the City of Portland's Stormwater Management Manual current at the time of building plan review. For all projects, the Stormwater Destination/Disposal Hierarchy must be addressed (pages 1-18 and 1-19 of the Stormwater Management Manual). Free CD-ROM discs of the 2004 Stormwater Management Manual are available at the City of Portland Development Services Center, 1900 SW 4<sup>th</sup> Avenue or on the internet at [www.portlandonline.com/bes/](http://www.portlandonline.com/bes/). The applicant may also contact BES with any questions or for additional information.

1. There is no City-owned storm-only sewer available to this property.

### Conditions of Approval

BES has no recommended conditions of approval.

### Additional Information

1. If commercial tenants have food prep activity areas, the Pollution Prevention Group highly recommends the removal of all food/garbage disposals and the installation of grease management devices where appropriate. These steps will help reduce the extra strength sewer charges this facility may incur in the near future. Additionally, by reducing the amount of food wastes, grease and solids that are rinsed down the drain, this facility's potential to cause an obstruction in the main sewer line will be reduced and unnecessary repair costs avoided.
2. To comply with the City's Extra Strength Sewerage Charge (ESSC) Program, facilities that have a likelihood of having high strength wastewater shall provide a structure for sampling. Facilities with high strength waste can include, but are not limited to; food processors, hotels, supermarkets, commercial kitchens, breweries, bakeries, restaurants, or any facility that may contain those operations.

ESSC sampling points are typically installed downstream of grease treatment structures, and are placed in the sanitary waste line at a location that accounts for all discharge flows from the activity areas subject to the ESSC program requirements.

A plumbing clean-out on the waste line may accommodate sampling needs; however, the location of the clean-out needs to be out of the way of traffic or standard operations of the facility, and in a space that measures 3' W X 3' L X 3' H. If this does not suit your development, alternatives can be discussed and a structural manhole or vault may be necessary. For assistance please contact the Pollution Prevention Group at 503-823-7122.

### Building Permit Information

1. The pertinent design requirements of the Stormwater Management Manual (SWMM) Chapter 4 are briefly described as follows (please read chapter 4 of the SWMM to help recognize any requirements we may have overlooked). The Stormwater Management Manual is available on the Internet at:  
<http://www.portlandonline.com/bes/index.cfm?c=35117>:
  - Solid waste and recycling areas require pavement underneath the receptacles, protection from stormwater/rainwater through berming or grading (hydraulic isolation), a structural cover that is relative in size to the perimeter of the trash/recycling area, and a sanitary (waste line) drain inside the bermed/graded area. Depending on where the area is located, a planning/design review may be required. If the covered area is large, a structural engineering review may be required for the structural cover.
  - Catch basins located in covered parking areas are required to discharge to the sanitary sewer. Trench drains or catch basins located at the entrance into the parking structure may discharge to the storm sewer system.
  - Loading docks (material transfer areas) require protection from stormwater/rainwater within the first 3 feet of the dock face (hydraulic isolation). This area cannot accept stormwater run-on and must be plumbed to the sanitary sewer.

**Neighborhood Review:** A Notice of Proposal in Your Neighborhood was mailed on May 20, 2008. 3 written responses have been received from either the Neighborhood Association or notified property owners in response to the proposal.

## ZONING CODE APPROVAL CRITERIA

### Chapter 33.825 Design Review

#### Section 33.825.010 Purpose of Design Review

Design review ensures that development conserves and enhances the recognized special design values of a site or area. Design review is used to ensure the conservation, enhancement, and continued vitality of the identified scenic, architectural, and cultural values of each design district or area. Design review ensures that certain types of infill development will be compatible with the neighborhood and enhance the area. Design review is also used in certain cases to review public and private projects to ensure that they are of a high design quality.

#### Section 33.825.055 Design Review Approval Criteria

A design review application will be approved if the review body finds the applicant to have shown that the proposal complies with the design guidelines for the area.

**Findings:** The site is designated with design overlay zoning (d), therefore the proposal requires Design Review approval. Because of the site's location, the applicable design guidelines are the Gateway Regional Center Design Guidelines.

#### Gateway Regional Center Design Guidelines

The Gateway Regional Center is the City of Portland's only designated regional center. The area is envisioned to redevelop into a highly urbanized, pedestrian-oriented center, with an overall built size and scale second only to Portland's Central City.

The purpose of design review is to carry out the urban design vision for the District by emphasizing unique district assets in a manner that is respectful, creative, supportive, and compatible with all its areas. Although the District is a complex urban environment, it can become a cohesive whole with the use of these design principles.

#### Gateway Regional Center Design Goals

Ten goals for design review in the Gateway Regional Center have been established to enhance the area's design quality, support its livability, and guide its transition to a pedestrian-oriented, active, urban regional center. They are:

1. Encourage urban design excellence.
2. Ensure that new development is at a human scale and that it relates to the scale and desired character of its setting and the Gateway Regional Center as a whole.
3. Provide for a pleasant, rich, and diverse experience for pedestrians.
4. Assist in creating a regional center that emphasizes a mix of active uses and experiences and is safe, lively, and prosperous.
5. Provide for the humanization of the Gateway Regional Center through the promotion of parks, plazas, open spaces, public art, and trees.
6. Integrate and honor the diversity and history of Gateway.
7. Integrate sustainable principles into the development process.
8. Encourage the development of a distinctive character for subdistricts within the regional center, and link them.
9. Encourage and incorporate transit orientation and usage.
10. Enhance the physical and visual linkages between the Gateway Regional Center and adjacent neighborhoods.

*Staff has considered all guidelines and has addressed only those guidelines considered applicable to this project.*

### **A Pedestrian Emphasis**

**A2. Enhance Visual and Physical Connections.** Enhance visual and physical connections between buildings and adjacent sidewalks. Orient semi-public building spaces to the sidewalk and street.

**Findings:** The proposed renovation of the existing building will retain the existing storefront glazing on the SE Stark Street façade. This will allow views into active areas of the building. The public entry and lobby will also remain on the SE Stark Street side of the building, oriented to the sidewalk and street. Two large garage doors and one man-door on the SE 102<sup>nd</sup> Avenue façade are being filled in with concrete block, painted to match the existing building. Two secondary windows on the east façade are remaining and will offer views into the building. The reflective UV film being placed on the inside face of the south elevation upper storefront glazing will be above the interior ceiling system and will not block any views into active areas of the building. *This guideline is therefore met.*

**A3. Integrate Building Mechanical Equipment and Service Areas.** Incorporate building mechanical equipment and/or service areas in a manner that does not detract from the pedestrian environment.

**Findings:** There are currently two existing mechanical units located on the roof. The proposed new mechanical units will also be located on the roof, away from the pedestrian environment. The existing service bay garage doors on the SE 102<sup>nd</sup> Avenue façade are being removed and filled in with concrete block. This will improve the pedestrian environment by removing a visually unappealing service area along SE 102<sup>nd</sup> Avenue. *This guideline is therefore met.*

## **B Development Design**

**B3. Design for Coherency.** Integrate the different parts of a building to achieve a coherent design.

**Findings:** The project will retain the overall form, curved roof with canopy, stone accent panels, columns and sign band of the original building. New storefront doors and glazing panels will be aluminum frames with clear glazing in a color and profile to match the current storefront. All new exterior wall will be constructed of matching, painted the same colors as the existing building. New exterior light fixtures at the canopy and above the exterior doors compliment the spare, warehouse style of the building and will not detract from the thin front columns or the exterior canopy sign band. *This guideline is therefore met.*

**B5. Integrate Roofs, Rooftop Lighting, and Signs.** Integrate rooftop components, functions and related screening elements with the building's architecture. Integrate exterior lighting, signs and any related structural equipment at or near the roof with the building's architecture. Orient lighting to highlight the building's architecture.

**Findings:** The new mechanical units will be placed on the roof consistent with existing units already in place. A new internally-illuminated sign will be integrated into the existing south elevation sign band and the transformer will be enclosed within the band. There is a non-conforming freestanding pole sign near the southwest corner of the site. This sign and pole mountings will be removed and replaced with new landscaping. *This guideline is therefore met.*

**B6. Integrate Ecological / Sustainable Concepts.** Integrate ecological/sustainable features or concepts with site and development designs.

**Findings:** New landscaped stormwater management facilities are being installed along the southern edge of the site. While these will not handle all stormwater from the building and parking lot, they are positive sustainable design features that contribute to the continued improvement of the area. *This guideline is therefore met.*

## C Context Enhancement

**C4. Develop Complementary Parking Areas.** Develop, orient and screen parking area to complement adjacent buildings and the pedestrian environment.

**Findings:** The existing building is set very far back from the adjacent streets and is surrounded on three sides by surface parking lots. The parking lot is being upgraded with new interior landscaping consisting of trees, shrubs and groundcover; new landscaped stormwater facilities will be placed along the southern edge of the site and new perimeter landscaping consisting of street trees, shrubs and groundcover will be installed along both SE Stark Street and SE 102<sup>nd</sup> Avenue. The perimeter and parking lot landscaping along the eastern portion of the property will mitigate the current view of the long cmu building wall facing SE 102<sup>nd</sup> Avenue. The sidewalk along the SE 102<sup>nd</sup> Avenue property frontage is being rebuilt. While the site layout remains essentially the same, the pedestrian environment along both SE Stark Street and SE 102<sup>nd</sup> Avenue will be enhanced with the new landscaping treatments. *This guideline is therefore met.*

## DEVELOPMENT STANDARDS

Unless specifically required in the approval criteria listed above, this proposal does not have to meet the development standards in order to be approved during this review process. The plans submitted for a building or zoning permit must demonstrate that all development standards of Title 33, Portland Zoning Code can be met, or have received an Adjustment or Modification via a land use review prior to the approval of a building or zoning permit.

## CONCLUSIONS

The proposed alterations to the existing building are consistent with the style of the building and do not negatively affect it. Views into the building through the large storefront glazing on the south elevation and the secondary windows on the east elevation will remain. Revisions to the parking areas, including new landscaping, stormwater facilities, and the removal of the large freestanding sign bring the site closer to the vision outlined in the Gateway Regional Center Design Guidelines by enhancing the pedestrian experience at the street, using sustainable concepts on the site, and moving away from auto-oriented development.

## ADMINISTRATIVE DECISION

Approval of exterior renovations to the existing building and parking lot as listed below per Exhibits C-1 through C-21:

1. New glazed entry door in the south façade.
2. Filling two garage doors and one man door in with concrete block on the east façade.
3. Two new man doors and a concrete stair with handrail along the east façade.
4. New illuminated sign across the front canopy sign band.
5. New canopy downlights and rear door security lights.
6. New rooftop mechanical unit.
7. Renovated parking lot landscaping and stormwater facilities.
8. Removal of the freestanding sign posts and cabinet.
9. UV reflective film on upper windows along the south façade.

Approval conditions of:

A. As part of the building permit application submittal, each of the 4 required site plans and any additional drawings must reflect the information and design approved by this land use review as indicated in Exhibits C-1 through C-21. The sheets on which this information appears must be labeled, "Proposal and design as approved in Case File # LU 08-103034 DZ. No field changes allowed."

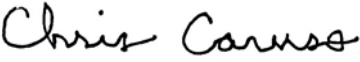
**Decision rendered by:**  **on June 11, 2008.**

By authority of the Director of the Bureau of Development Services

**Decision mailed: June 13, 2008**

**Staff Planner: Chris Caruso**

**About this Decision.** This land use decision is **not a permit** for development. Permits may be required prior to any work. Contact the Development Services Center at 503-823-7310 for information about permits.

**Procedural Information.** The application for this land use review was submitted on January 16, 2008, and was determined to be complete on **May 15, 2008.**

*Zoning Code Section 33.700.080* states that Land Use Review applications are reviewed under the regulations in effect at the time the application was submitted, provided that the application is complete at the time of submittal, or complete within 180 days. Therefore this application was reviewed against the Zoning Code in effect on January 16, 2008.

*ORS 227.178* states the City must issue a final decision on Land Use Review applications within 120-days of the application being deemed complete. The 120-day review period may be waived or extended at the request of the applicant. In this case, the applicant did not waive or extend the 120-day review period.

**Some of the information contained in this report was provided by the applicant.**

As required by Section 33.800.060 of the Portland Zoning Code, the burden of proof is on the applicant to show that the approval criteria are met. The Bureau of Development Services has independently reviewed the information submitted by the applicant and has included this information only where the Bureau of Development Services has determined the information satisfactorily demonstrates compliance with the applicable approval criteria. This report is the decision of the Bureau of Development Services with input from other City and public agencies.

**Conditions of Approval.** If approved, this project may be subject to a number of specific conditions, listed above. Compliance with the applicable conditions of approval must be documented in all related permit applications. Plans and drawings submitted during the permitting process must illustrate how applicable conditions of approval are met. Any project elements that are specifically required by conditions of approval must be shown on the plans, and labeled as such.

These conditions of approval run with the land, unless modified by future land use reviews. As used in the conditions, the term "applicant" includes the applicant for this land use review, any person undertaking development pursuant to this land use review, the proprietor of the use or development approved by this land use review, and the current owner and future owners of the property subject to this land use review.

**Appealing this decision.** This decision may be appealed to the Design Commission, which will hold a public hearing. Appeals must be filed **by 4:30 PM on June 27, 2008** at 1900 SW Fourth Ave. Appeals can be filed on the first floor in the Development Services Center until 3 p.m. After 3 p.m., appeals must be submitted to the receptionist at the front desk on the fifth floor. **An appeal fee of \$250 will be charged.** The appeal fee will be refunded if the appellant



prevails. Recognized neighborhood associations are not subject to the appeal fee. Low-income individuals appealing a decision for their personal residence that they own in whole or in part may qualify for an appeal fee waiver. In addition, an appeal fee may be waived for a low income individual if the individual resides within the required notification area for the review, and the individual has resided at that address for at least 60 days. Assistance in filing the appeal and information on fee waivers is available from BDS in the Development Services Center. Fee waivers for low-income individuals must be approved prior to filing the appeal; please allow 3 working days for fee waiver approval. Please see the appeal form for additional information.

The file and all evidence on this case are available for your review by appointment only. Please contact the receptionist at 503-823-7967 to schedule an appointment. I can provide some information over the phone. Copies of all information in the file can be obtained for a fee equal to the cost of services. Additional information about the City of Portland, city bureaus, and a digital copy of the Portland Zoning Code is available on the internet at [www.portlandonline.com](http://www.portlandonline.com).

**Attending the hearing.** If this decision is appealed, a hearing will be scheduled, and you will be notified of the date and time of the hearing. The decision of the Design Commission is final; any further appeal must be made to the Oregon Land Use Board of Appeals (LUBA) within 21 days of the date of mailing the decision, pursuant to ORS 197.620 and 197.830. Contact LUBA at 550 Capitol St. NE, Suite 235, Salem, Oregon 97301, or phone 1-503-373-1265 for further information.

Failure to raise an issue by the close of the record at or following the final hearing on this case, in person or by letter, may preclude an appeal to the Land Use Board of Appeals (LUBA) on that issue. Also, if you do not raise an issue with enough specificity to give the Design Commission an opportunity to respond to it, that also may preclude an appeal to LUBA on that issue.

**Recording the final decision.**

If this Land Use Review is approved the final decision must be recorded with the Multnomah County Recorder. A few days prior to the last day to appeal, the City will mail instructions to the applicant for recording the documents associated with their final land use decision.

- *Unless appealed*, The final decision may be recorded on or after **June 30, 2008**.
- A building or zoning permit will be issued only after the final decision is recorded.

The applicant, builder, or a representative may record the final decision as follows:

- **By Mail:** Send the two recording sheets (sent in separate mailing) and the final Land Use Review decision with a check made payable to the Multnomah County Recorder to: Multnomah County Recorder, P.O. Box 5007, Portland OR 97208. The recording fee is identified on the recording sheet. Please include a self-addressed, stamped envelope.
- **In Person:** Bring the two recording sheets (sent in separate mailing) and the final Land Use Review decision with a check made payable to the Multnomah County Recorder to the County Recorder's office located at 501 SE Hawthorne Boulevard, #158, Portland OR 97214. The recording fee is identified on the recording sheet.

For further information on recording, please call the County Recorder at 503-988-3034  
For further information on your recording documents please call the Bureau of Development Services Land Use Services Division at 503-823-0625.

**Expiration of this approval.** An approval expires three years from the date the final decision is rendered unless a building permit has been issued, or the approved activity has begun.

Where a site has received approval for multiple developments, and a building permit is not issued for all of the approved development within three years of the date of the final decision, a new land use review will be required before a permit will be issued for the remaining development, subject to the Zoning Code in effect at that time.

Zone Change and Comprehensive Plan Map Amendment approvals do not expire.

**Applying for your permits.** A building permit, occupancy permit, or development permit may be required before carrying out an approved project. At the time they apply for a permit, permittees must demonstrate compliance with:

- All conditions imposed herein;
- All applicable development standards, unless specifically exempted as part of this land use review;
- All requirements of the building code; and
- All provisions of the Municipal Code of the City of Portland, and all other applicable ordinances, provisions and regulations of the City.

### **EXHIBITS**

NOT ATTACHED UNLESS INDICATED

- A. Applicant's Statement
- B. Zoning Map (attached)
- C. Plans/Drawings:
  - 1. C1 Site Plan (attached)
  - 2. L1 Landscape Plan [attached]
  - 3. A1.0 Demo Plan
  - 4. A1.1 Floor Plan
  - 5. A2.1 Details
  - 6. A3 Schedule
  - 7. Cover Sheet
  - 8. A4.0 Exterior Elevations [attached]
  - 9. A4.1 Roof Plan
  - 10. Gas Piping and CEF
  - 11. Schedules and Details
  - 12. Sign layout [attached]
  - 13. C1.0 Cover Sheet
  - 14. C2.0 Site Dimension Plan
  - 15. Onsite Storm Improvements
  - 16. Site Details
  - 17. Storm Drainage Basin Map Onsite Storm Improvements
  - 18. Split Face CMU Block sample
  - 19. Window Film sample
  - 20. Lighting Locations and cut sheets
  - 21. Rooftop units cut sheets and specifications
- D. Notification information:
  - 1. Mailing list
  - 2. Mailed notice
- E. Agency Responses:
  - 1. Site Development Section of BDS
  - 2. Life Safety Section of BDS
  - 3. Bureau of Environmental Services
- F. Correspondence:
  - 1. Justin Douglas, Portland Development Commission, June 9, 2008, in support.
  - 2. Arlene Kimura, Hazelwood Neighborhood Association, June 9, 2008, qualified support with concerns about security, appropriate use, the east wall, and landscaping.
  - 3. Joe Mitchoff, Ridgeway Development, June 9, 2008, in support.
- G. Other:
  - 1. Original LU Application
  - 2. Site History Research
  - 3. Tax Map
  - 4. Incomplete Letter
  - 5. April 1, 2008 Site Development Completeness Review Response

6. May 12, 2008 applicant stormwater memo
7. Site Photos [8 pages)

**The Bureau of Development Services is committed to providing equal access to information and hearings. If you need special accommodations, please call 503-823-0625 (TTY 503-823-6868).**

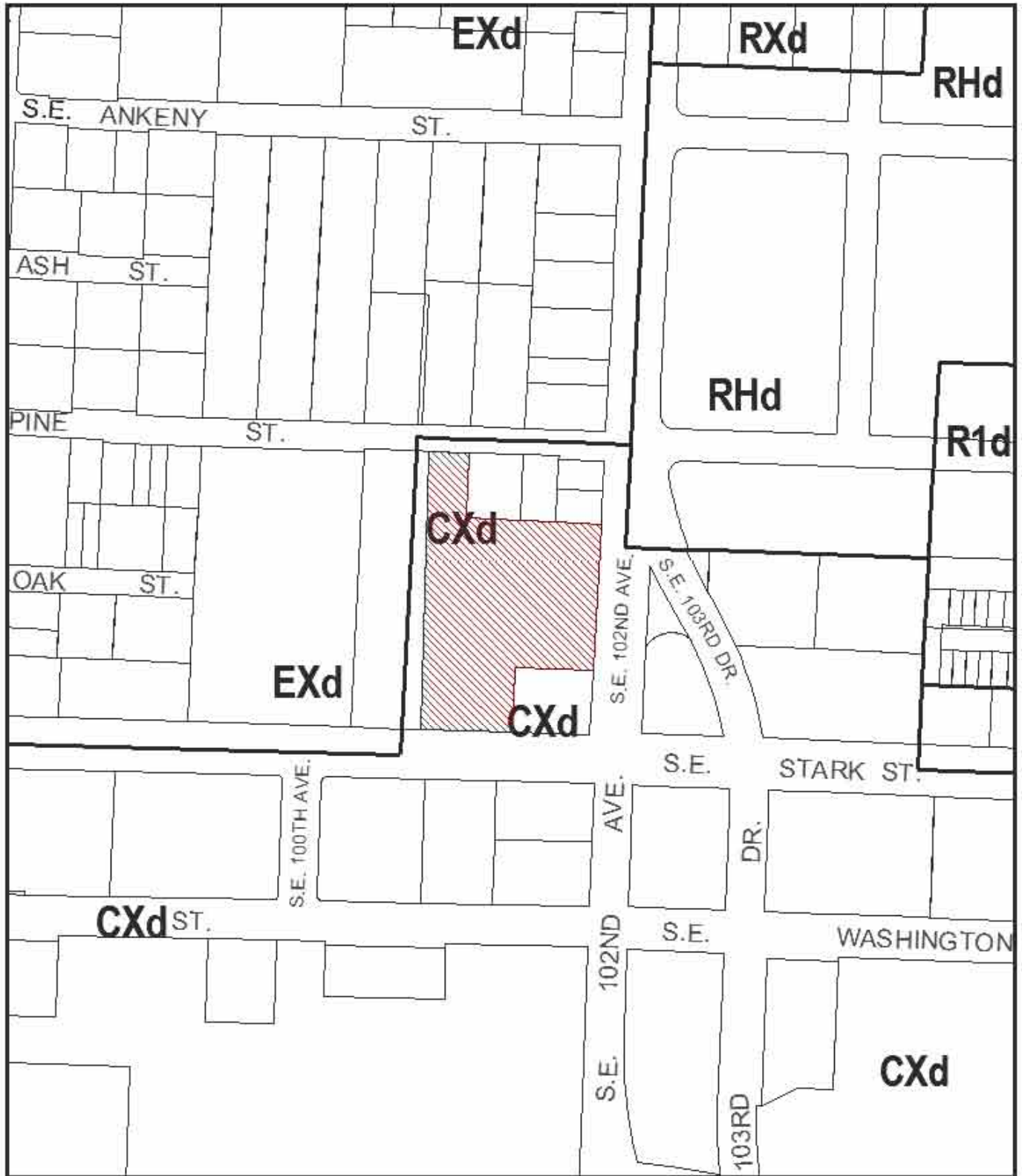

# ZONING



This site lies within the:  
GATEWAY PLAN DISTRICT

File No.	LU 08-103034 DZ
1/4 Section	3040,3041,3140,3141
Scale	1 inch = 200 feet
State_Id	1N2E33DD 5400
Exhibit	B (Jan 22,2008)

**SITE NOTES:**

1. THE EXISTING BUILDING SHALL BE MAINTAINED AS WEATHER TIGHT AS POSSIBLE DURING THE DEMOLITION AND RENOVATION CONSTRUCTION PROCESS.
2. APPROXIMATE ELEVATION 307
3. LOT 5400 - 1.85 AC. SEE SC 34101
4. EXISTING ASPHALT PARKING LOT TO REMAIN
  - 87 PARKING SPACES
  - 4 HANDICAP ACCESSIBLE SPACES
  - 91 TOTAL PARKING SPACES

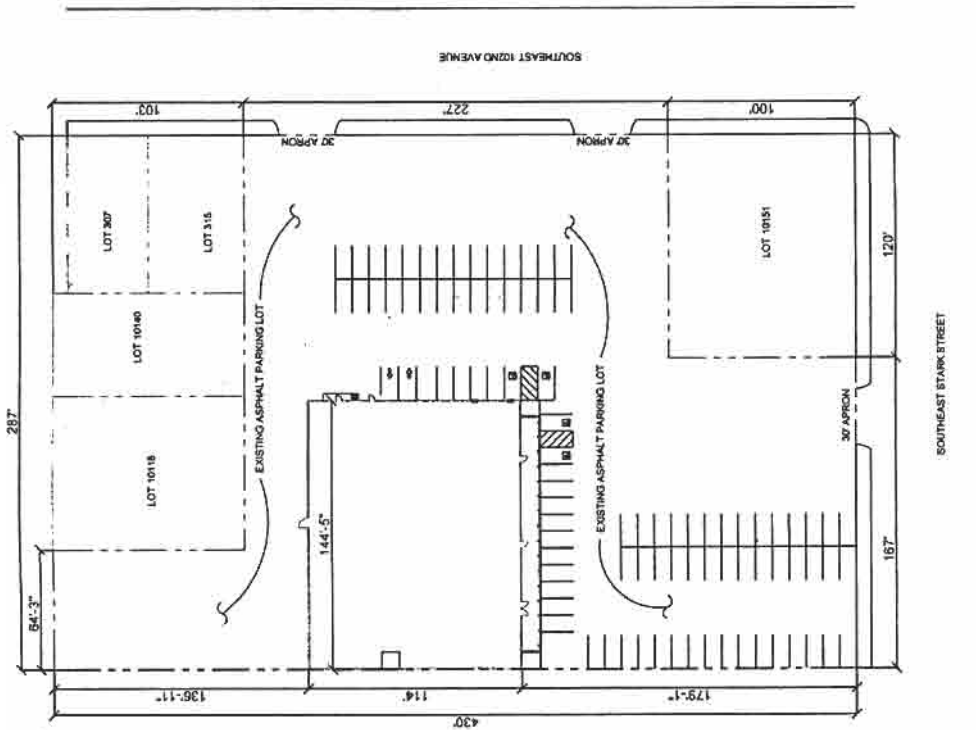

1 SITE PLAN  
 6/1/16" = 1"

**\*Approved\***  
 City of Portland  
 Bureau of Development Services  
 Planner *R. Williams*  
 Date *6/11/08*  
 \* This approval applies only to the  
 reviews requested and is subject to all  
 conditions of approval.  
 Additional zoning requirements may apply.

*UU 08-103084 DZ*



OWEN GROVER ENGINEERING P.C.  
 1050 BETHEL DRIVE, SUITE D4  
 EUGENE, OREGON 97402

LANDSCAPING PLAN

IBR  
 10115 SE STARK  
 PORTLAND, OR

REVISIONS	BY

DATE 11/15/2007  
 SCALE 1/8" = 1'  
 DRAWN CNH  
 JOB 07285  
 SHEET

**C1**

*\*Approved\**  
 City of Portland Services  
 Bureau of Development Services  
 Planner *6/11/06*  
 Date

\* This approval applies only to all reviews requested and is subject to all conditions of approval.  
 Additional zoning requirements may apply.

GENERAL NOTES

1. PROVIDE QUANTITY, SIZE, COLOR, SPECIES AND VARIETY AS SHOWN AND COMPATIBLE WITH ADJ. P.L. NO.
2. ALL PLANT BEDS TO BE MITIGATED BY AN ANTI-EROSION, AUTOMATIC REGULATION STREET WASH WASH TO HEAD COVERAGE PROVIDE PVC BODDLE AS SHOWN BELIEF TO ALL PLANT BEDS.
3. ADD 2" SURFEED BARK MULCH TO ALL PLANT BEDS AS SHOWN.
4. LANDSCAPE PLANTS FOR A ONE YEAR PERIOD AFTER DATE OF INSTALLATION. ALL PLANTS SHALL BE MAINTAINED AND WATERED BY THE CONTRACTOR FOR ONE YEAR AFTER INSTALLATION. ALL PLANTS SHALL BE MAINTAINED AND WATERED BY THE CONTRACTOR FOR ONE YEAR AFTER INSTALLATION.
5. TOTAL VEHICLE PARKING: 44 (INCLUDES 3 ADA SPACES). RECORD-DRAWN AUTOMATED LANDSCAPING (AS APPLICABLE) SHALL BE PERFORMED IN ACCORDANCE WITH THE CITY OF PORTLAND ZONING ORDINANCES.

SITE IMPROVEMENTS

CONSTRUCTION ITEM	QTY	COST
CONTRACTOR MOBILIZATION	1	1500
REMOVE PAVING FOR PLANT BEDS	360 L.F.	15000
REMOVE AC PAVING / EXCAVATE TO 0' DEPTH	140 C.Y.	15000
AC PAVING FOR REGULATION TRENCHES	1000 S.F.	15000
DIVULSED CONCRETE CURB (4")	700 L.F.	14000
PARKING LOT STRIPING	140 C.Y.	14000
REGULATION STREET MARKING-PURVE VALVE	1	1000
REPAVING AND GROUNDCOVER	1	10000
BANK MULCH	1	1000
DIVERSIFIED / FRONT END	1	15000
TOTAL		146000

PLANT LIST

QTY	SYMBOL	SCIENTIFIC / COMMON NAME	SIZE / REMARKS
7	CAL.	ACER RUBENSII / RED SWEDD MAPLE	7" CAL.
7	CAL.	GALNUS ACOULOS / STURGEON OAK	7" CAL.
7	CAL.	PERSEA SERRULATA / SPANISH MOUNTAIN LIME	7" CAL.
7	CAL.	PERSEA SERRULATA / SPANISH MOUNTAIN LIME	7" CAL.
3	3.0AL	QUERCUS TURBOCORA / JAPANESE BARKSPEE	3" CAL.
3	3.0AL	QUERCUS TURBOCORA / JAPANESE BARKSPEE	3" CAL.
3	3.0AL	QUERCUS TURBOCORA / JAPANESE BARKSPEE	3" CAL.
3	3.0AL	QUERCUS TURBOCORA / JAPANESE BARKSPEE	3" CAL.
3	3.0AL	QUERCUS TURBOCORA / JAPANESE BARKSPEE	3" CAL.
3	3.0AL	QUERCUS TURBOCORA / JAPANESE BARKSPEE	3" CAL.
3	3.0AL	QUERCUS TURBOCORA / JAPANESE BARKSPEE	3" CAL.
3	3.0AL	QUERCUS TURBOCORA / JAPANESE BARKSPEE	3" CAL.
3	3.0AL	QUERCUS TURBOCORA / JAPANESE BARKSPEE	3" CAL.
3	3.0AL	QUERCUS TURBOCORA / JAPANESE BARKSPEE	3" CAL.
3	3.0AL	QUERCUS TURBOCORA / JAPANESE BARKSPEE	3" CAL.
3	3.0AL	QUERCUS TURBOCORA / JAPANESE BARKSPEE	3" CAL.
3	3.0AL	QUERCUS TURBOCORA / JAPANESE BARKSPEE	3" CAL.
3	3.0AL	QUERCUS TURBOCORA / JAPANESE BARKSPEE	3" CAL.
3	3.0AL	QUERCUS TURBOCORA / JAPANESE BARKSPEE	3" CAL.
3	3.0AL	QUERCUS TURBOCORA / JAPANESE BARKSPEE	3" CAL.
3	3.0AL	QUERCUS TURBOCORA / JAPANESE BARKSPEE	3" CAL.
3	3.0AL	QUERCUS TURBOCORA / JAPANESE BARKSPEE	3" CAL.

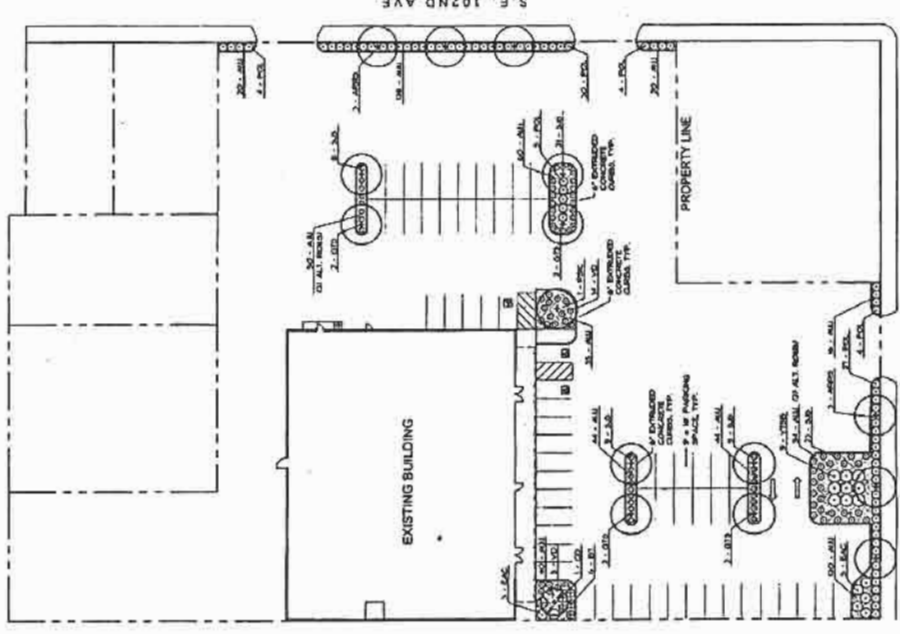

EXISTING BUILDING  
 S.E. STARK ST.  
 S.E. 102ND AVE.

REGISTERED ARCHITECT  
 OREGON  
 B RAMBERG, Inc.  
 1600 Westlec Drive  
 Eugene, OR 97402  
 541-587-2841  
 McInyre Construction, Inc.  
 1500 Westlec Drive  
 Eugene, OR 97402  
 541-587-2841  
 PORTLAND, OR  
 10115 SE STARK  
 IBR  
 PERMIT #07-17792-000-00-CO

REVISIONS	BY
DATE	02-22-08
SCALE	1" = 20'-0"
DRAWN	Kh
APP	07/26/05
SHEET	L1

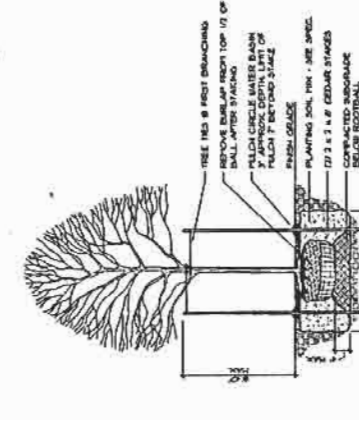
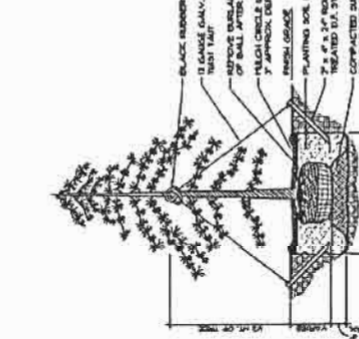

DECIDUOUS TREE PLANTING DETAIL  
 SCALE: N.T.S.

CONIFER TREE PLANTING DETAIL  
 SCALE: N.T.S.

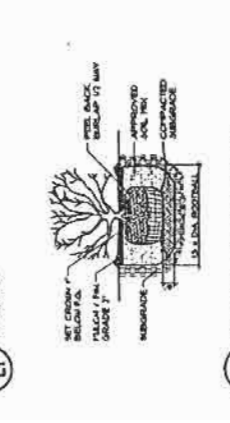
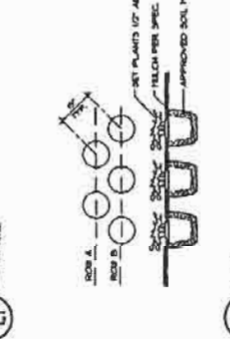

SHRUB PLANTING DETAIL  
 SCALE: N.T.S.

GROUNDCOVER PLANTING DETAIL  
 SCALE: N.T.S.

LU 08-103034 D2

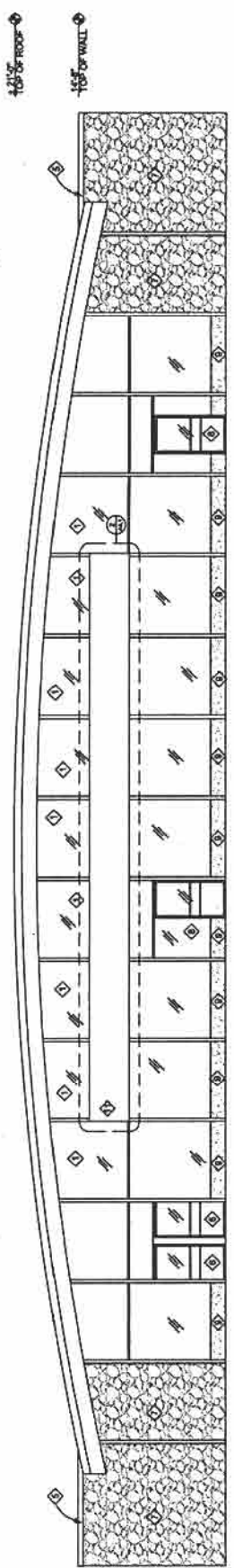

**1 SOUTH ELEVATION**  
 SCALE: 3/16" = 1'-0"

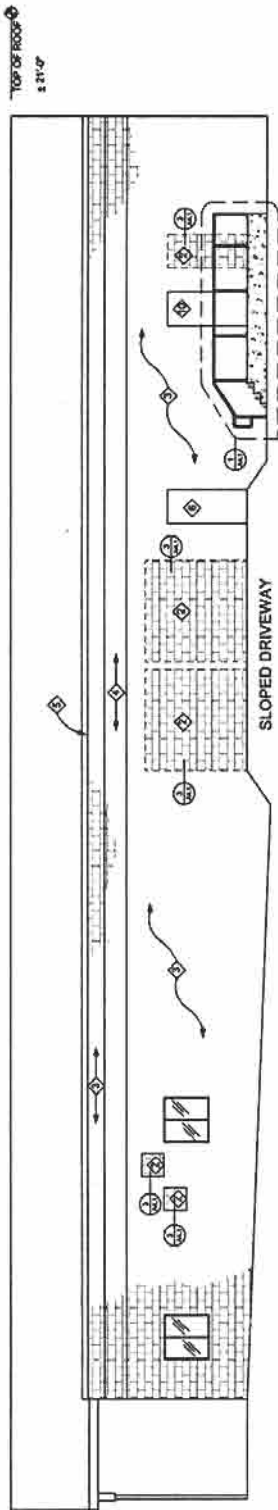

**2 EAST ELEVATION**  
 SCALE: 3/16" = 1'-0"

**ELEVATION NOTES:**

- 1 APPLY REFLECTIVE FILM TO INSIDE FACE OF EXISTING STOREFRONT GLAZING
- 2 EXTERIOR WALL OPENING FROM DEMOLITION FILLED WITH CMU BLOCK
- 3 NEW WHITE PAINT TO MATCH EXISTING
- 4 NEW BLUE PAINT TO MATCH EXISTING
- 5 REPLACE FLASHING AS NECESSARY, NEW BLUE PAINT TO MATCH EXISTING
- 6 EXISTING DOOR TO REMAIN
- 7 EXISTING STONE WORK TO REMAIN
- 8 NEW STOREFRONT PANEL, SEE SCHEDULE
- 9 NEW SPLIT FACE BLOCK, WHITE PAINT TO MATCH EXISTING
- 10 NEW FRAME, DOOR & HARDWARE TO MATCH EXISTING DOOR, SEE SCHEDULE
- 11 EXISTING SIGN BAND AND COLUMNS, NEW BLUE PAINT TO MATCH EXISTING

**GENERAL ELEVATION NOTES:**

NO EXTERIOR CHANGES TO NORTH & WEST ELEVATION.  
 ONLY CLEAN UP AND NEW PAINT.  
 ALL PAINT TO MATCH EXISTING

**STOREFRONT DOORS:**

DOORS: NARROW STYLE #250 US ALUMINUM W/ 2-1/2" RAILS, 10" ADA BOTTOM RAIL. THE FRAME IS 451 CENTER GLAZED.

HARDWARE: HANDLES: PRO 34 & 32 RADIUS PUSH PULL COMBINATION; HINGLES: FULL COUNTERDOWN HINGEL; LOCK: LOCK WITH KEY AND TURN; SCULPTURE C RETWAY CYLINDERS & 854999 LOCK INDICATORS

**METAL EXTERIOR DOORS:**

DOORS: 2" HOLLOW METAL DOOR

HARDWARE: HANDLES: SARGENT LOCKSET 1000M LL; HINGLES: MONKEY BUTT'S T42714 4.5 X 4.5 NRP; ALUM THRESHOLD 271A; ALUM RAIN DRIP 345A; SEALS P3074

\*Approved\*  
 City of Portland  
 Bureau of Development Services  
 Planner *[Signature]*  
 Date *6/11/08*  
 This approval applies only to the all relevant submissions that may apply. Additional zoning requirements may apply.



2611 EL CAMINO  
HOUSTON, TEXAS 77054  
TEL: 713.863.0500 - FAX: 713.863.7585  
www.NationalSigns.com

PROJECT: YALECRIS PLASMA CENTER  
LOCATION: 10115 SOUTHEAST STARK  
CITY/STATE: PORTLAND, OR 97292  
SALES REP: CHRIS KRUG  
DATE : 2.18.2008  
DRAWN BY: RANDY H.  
APPROVED BY: CHRIS KRUG  
DATE: 2.18.2008

**CLIENT APPROVAL**

COPYRIGHT  
THIS RENDERING IS THE PROPERTY OF NATIONAL SIGNS, INC. ANY REPRODUCTION OR EXHIBITION OF THIS DRAWING IS STRICTLY PROHIBITED. © 2008 NATIONAL SIGNS, INC. ALL RIGHTS RESERVED.

120 VOLT ELECTRICAL SERVICE  
CLIENT TO PROVIDE ALL PRIMARY ELECTRICAL SERVICES TO THE SIGN UNLESS OTHERWISE SPECIFIED.

SIGNED: \_\_\_\_\_  
DATE: \_\_\_\_\_

**SALES REP. APPROVAL**

SIGNED: \_\_\_\_\_  
DATE: \_\_\_\_\_

**LANDLORD APPROVAL**

SIGNED: \_\_\_\_\_  
DATE: \_\_\_\_\_

**REVISIONS**

UL INSTALLATION REQUIREMENTS  
THIS SIGN IS INTENDED TO BE INSTALLED IN ACCORDANCE WITH THE NATIONAL ELECTRICAL CODE AND ALL OTHER APPLICABLE LOCAL CODES. THIS INCLUDES PROPER GROUNDING AND BONDING OF THE SIGN.

LU 00-103034 P2

CONNECTOR. PAINT TO MATCH FASCIA.

9'-9 3/4"

3'-4 1/4"

2'-1 1/2"

7"

# Talecris

PLASMA RESOURCES

FRONT VIEW  
SCALE: 3/4" = 1'-0"

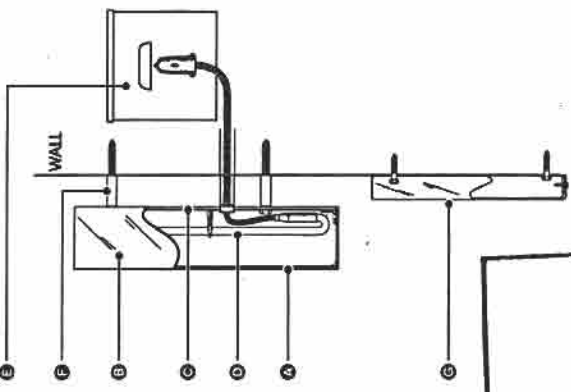

**SPECIFICATIONS**

FABRICATE AND INSTALL (1) SET OF REVERSE ILLUMINATED CHANNEL LETTERS AND (1) NON ILLUMINATED CHANNEL BOX.

- FACES: .125" ALUM. FINISH: WHITE
- 3M VIVID BLUE VINYL #220-17 APPLIED WITH 1/2" WHITE INSET BORDER.
- RETURNS: 5" DEEP .040 ALUMINUM PTM PMS BLUE #294
- BACKS: .150" CLEAR POLYCARBONATE
- ILLUMINATION: 15mm 6500 WHITE NEON
- TRANSFORMERS: 60VA REMOTE HOUSED IN TRANSFORMER CAN
- MOUNTED: INDIVIDUALLY ON WALL WITH 2" STANDOFF

USING MINIMUM 3/8" FASTENERS WALL MATERIAL: \_\_\_\_\_

PANEL: 1" DEEP BREAK FORMED WHITE ALUMINUM W/ 3M HP OLYMPIC BLUE # 220-57 VINYL COPY APPLIED

**VINYL COLORS**

- VIVID BLUE VINYL #220-17
- OLYMPIC BLUE VINYL #220-57

SCALE: 3/4" = 1'-0"

56'



Approved\*  
of Portland  
Development Services  
Planner  
Date 6/11/08

Page 2 of 2

\* This approval applies only to the reviews requested and is subject to all conditions of approval. Additional zoning requirements may apply.

SIGN LAYOUT  
SCALE: 1/16" = 1'-0"